



Ture Diversity MIC System

User Manual

T-530A/530B/530C

Before using the system, please read this manual first

Index

UHF Receiver Module Controls: Features & Indicators·····	2~6
Handheld Transmitter Controls: Features and Indicators·····	8~10
Body-Pack Transmitter Controls: Features and Indicators···	11~12
How to get the best performance ······	13~14
Specifications·····	14~15

Thank you for purchasing UHF true-single channel wireless Microphone system. Before set up the system, read the manual carefully to understand each part of the system.

The true Diversity Receiver UHF with 100 frequencies. It is designed for stage, conference room, school, church and many other applications. To get your system up and running in just a few minutes, please follow the simple instructions in this manual. For more information, refer to the sections of this manual that applies to your needs.

- ① Rack mountable bracket
- ② Power switch
- ③ UHF receiver module
- ④ Power jack: 12V DC/ 1,000 mA
- ⑤ Antenna Audio
- ⑥ Squelch and sensitivity controls
- ⑦ Unbalanced shared/mixed audio output jack
- ⑧ Balanced Output

UHF Receiver Features & Indicators

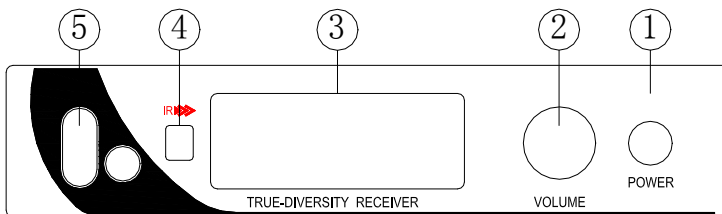

View of Front Panel

- ① Power switch
- ② Volume Controller

③LCD display shows frequency / channel, RF signals, Audio signal Strength, squelch.

④ACT(Automatic Channel Targeting) communication window. To make the easiest and fastest channel set up (pairing) between the transmitter and the receiver.

⑤Function keys: Press the key and hold for 2-3 seconds, then the key is selected, Press “▲▼” to select function, after the Function (frequency /channel/squelch) is selected; press the SET key again to confirm it.

View of Back Panel

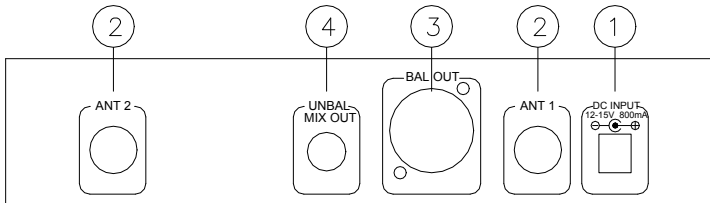

①Power jack: 12V DC/ 1,000 mA

②Antenna

③Balanced Output

④Unbalanced shared/mixed audio output jack

⑤Size; W210*H44*D148mm

II. Operation Receiver

1. Make sure that the transmitter is powered off before turning the receiver' s power on. Press the receiver power key, the LCD will glow and turn on. Then press “▲▼” to choose function and channel, press SET key to confirm the set. Check RF and AF signal strength when the transmitter signal becomes noisy, weak or fails. Then press “◀” or “▶” to choose a clearer channel, press SET key to confirm.
2. Press and hold the power key for 3 seconds to turn the receiver Off.

III. Operation of the LCD display

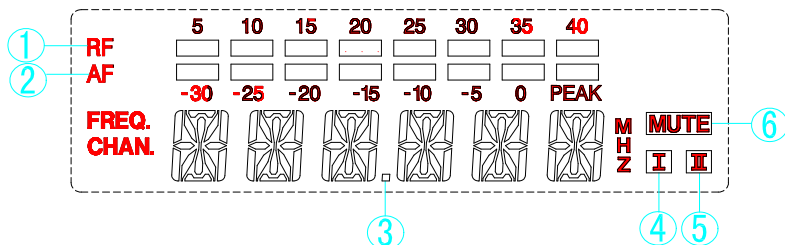

- ① RF bar indicators: 8-bar indicates the strength of radio frequency signal.
- ② AF bar indicators: 8-bar indicates the strength of audio signal
- ③ When the LCD shows FREQU, it is the current working frequency
- ④ When the LCD shows CHANNL, it is the current working channel.
- ⑤ 6-segment shows: frequency, channel and menu.
- ⑥ Mute sign shows that no RF signal is received.

Press and hold “SET” key to choose or confirm. Press “▲▼” key to change current frequency or channel then press “SET” key

again to confirm it. Use “SET” key to confirm transmitter working status. Press and hold the “▲▼” for a fast forward or backward.

When the strength sign shows and the frequency is the same as shown on the transmitter, it means the pairing is done successfully.

Receiver LCD Display

A. Main Menu

Press “SET” key, the picture below will present on display first

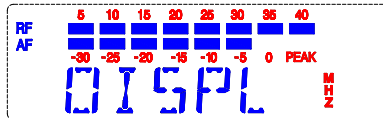

After 2-3 seconds, one of two pictures below will present: it depends on last status before turning the system off. The CPU of receiver remembers last status LCD displays what stored last time when the CPU was shut off.

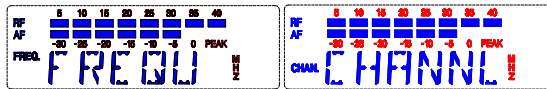

You can select CHANNL or FREQU when press “▲▼” key. It shows 0-99 digits when choose CHANNL; it shows real carrier frequency when you choose FREQU.

After your choice, Press “SET” key to confirm it, if you do not press SET to confirm it, the receiver will return to last status to work. The LCD will blink if no confirmation is made; this is to invite a confirmation. If you press SET key to confirm it, the LCD will stay firm.

B. How to adjust channel

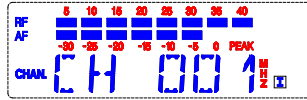

(The LCD will display one of the above depends on last status)

Press “SET” key for 2-3 seconds, LCD will present, CH 001. Press “◀” or “▶” key to change current channel. Press “SET” key to confirm, but the receiver will return to last channel to work after indicator flashes 2-3 seconds if not press “SET” key.

C. How to adjust frequency



Press “SET” key for 2-3 seconds; LCD will present a number like 798.000. Press“ ▲▼”key to change current working frequency, Press “SET” key to confirm, but the receiver will return to last state to work after indicator flash 2-3 seconds if not to press “SET” key.

D. How to adjust sensitivity of receiver



Press “SET” key for 2-3 seconds; LCD will present Squelch like 15 dB indicates sensitivity status. Press “▲▼” key to change current status if need. This point is a factory pre-set at: 0-40dB. 5, 10, 15, 20, 25, 30, 35, 40dB positions are to provide optimal operation in most applications. Position at 40 dB will decrease operating range.

E. System lock operation

Press “SET” key for 2-3 seconds, LCD will present as the following diagram.

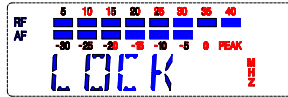

After 2-3 seconds, LCD will change to one of the following diagrams.

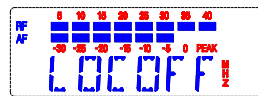
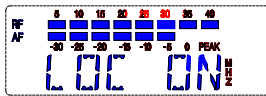

It depends on the last status when LCD was turned off to see what it will show now.

If the LCD shows LOC ON, you can do nothing on the system, even you cannot power off the system. Only when it shows LOC OFF, you can make changes.

If it is in LOCK ON mode, press “SET” key for 2-3 seconds, then press “▲▼” key to set to LOC OFF. You can change function at LOC OFF status. Press “SET” key to confirm it after changing function, otherwise receiver CPU keeps last status.

Handheld transmitter controls: Features and Indicators

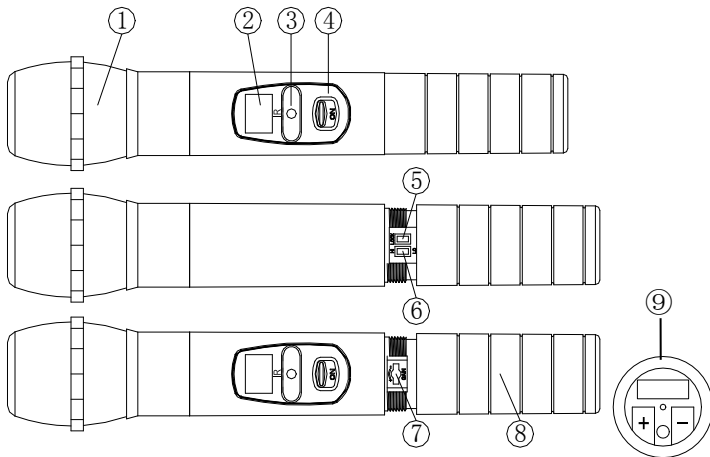

① Metal windscreen: Hexagonal-shaped to protect the microphone cartridge from being damaged, reducing breath sounds and wind noise.

② LCD display: Indicates channel and remaining battery level.

③ IR receiver window

④ Power key

⑤ RF output power level selector: High (Hi) or Low (Lo)

⑥ Lock On/Off switch: If it is set to lock, you cannot change anything from the keys.

⑦ Audio receiver gain selector: High / Low

⑧ Battery compartment: recommend Ni-MH AA batteries X 2 or AA rechargeable batteries.

⑨ Charger port put handheld microphone to UCH-09 charger to charge when LCD indicates low battery in handheld microphone
The UCH-09 charger can work two microphones at same time

Operating the handheld microphone

The display of handheld transmitter

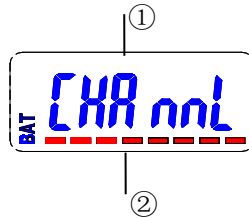

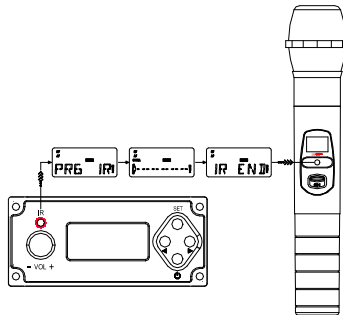

- ① 6-Letter display channel only
- ② 8-Bar remaining battery level

How to use ACT to pair the transmitter and receiver



ACT is a short for Automatic Channel Targeting. To make the easiest and fastest channel set up between the transmitter and receiver.

Turn both receiver and transmitter on, get the transmitter IR  window close to the receiver within 30 inches, press the SET key on the receiver, the sign  will show on the LCD, it is transmitting the frequency info to the transmitter, as soon as the

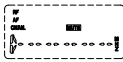
sign  shows on the LCD, the pairing is completed and the

frequency is set by the system. When the sign  shows, it means the pairing failed and you have to do it again as above stated. Repeat the procedure; you will get the pairing done quickly.

Body-Pack transmitter controls: Features and Indicators

Top View:



Bottom View:

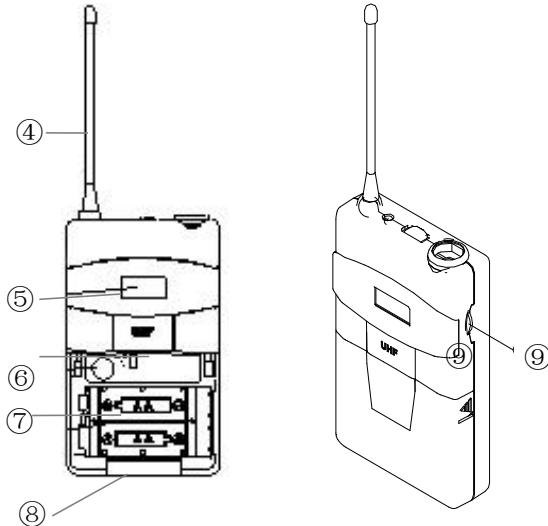
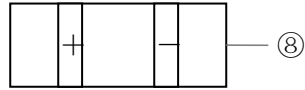

① Audio Input Jack

② Power switch: When the power switch is turned to ON position, the LED light will flash once, indicating it has a good amount of battery power; if the LED stays on or does not glow at all, the battery has low voltage or battery is set on a wrong polarity.

③ Low battery Indicator

④ Antenna

⑤ LCD Display: shows channel and battery level.

⑥ IR receiver window and switch RF output hi/low power.

⑦ Battery compartment : Recommend Ni-MH AA batteries×2 or AAX2 rechargeable batteries

⑧ Charger port: put body-pack microphone to UCH-09 Charger to charge when LCD shows low battery in body pack LCD. The UCH-09 charger can work with two microphones at the same time.

⑨ Volume control: To adjust the sound level of body pack transmitter

How to use ACT to pair the body pack and the receiver

ACT is a short for Automatic Channel Targeting. To make the easiest and fastest channel set up between the transmitter and receiver.

Turn both receiver and transmitter on, get the transmitter IR  window close to the receiver within 30 inches, press the SET key

on the receiver, the sign  will show on the LCD, it is transmitting the frequency info to the transmitter, as soon as the

sign  shows on the LCD, the pairing is completed and the

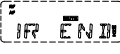
frequency is set by the system. When the sign  shows, it means the pairing failed and you have to do it again as above stated. Repeat the procedure, you will get the pairing done quickly.

How to get the best performance

If you are using more one set of the UHF TD-1, the following channels are recommended to avoid interference among the receiver modules as follows;

A	1/51	27/77	8/58	34/84	15/65
B	26/76	7/57	33/83	14/64	40/90
C	6/56	32/82	13/63	39/89	20/70
E	11/61	37/87	18/68	44/94	25/75
F	36/86	7/67	43/93	24/74	50/100
G	16/66	42/92	23/93	49/99	5/55
H	41/91	22/72	48/98	4/54	30/80
I	27/71	47/97	3/53	29/79	10/60
J	46/96	2/52	28/78	9/59	35/85

If you are using more than two set of the UHF TD-1 , it is better to have the two receiver sets apart from each other, at least 20 cm (10 inches), and the following two systems into the following channels will be suggested to set before use. Or you can try to use another channels for best performance no interfered such CH 4,10,28,45,57,75,78, 97 means 4 sets work together

Trouble shooting:

Some problems and their solutions are identified in the table below.

Problem	Solution
LCD not glowing	Check for proper connection between power adaptor and receiver
No RF signal on receiver	Check both transmitter and receiver channel/frequency correction
No AF signal on receiver	Check microphone audio cable connected body-pack, make sure output cable from receiver is connected
Noise from receiver When transmitter is off	Change frequency / channel, and lower sensitivity on receiver
Audio signal distorted	Decrease audio gain in transmitter and lower audio output in receiver
Short performance Distance and drop RF signal	Switch transmitter output power in hi position and set more sensitivity in receiver or channel frequency/channel Try to set up another pair of channel to test.

System Specifications

Frequency Range: UHF range 740-765MHz

Modulation Mode: PLL

Bandwidth: 25MHz

Channel: 100 Channel interval 25 KHz

Stability: +/-0.0005%

Dynamic Range: 100dB

Max Deviation: +/-80 KHz

Frequency Response: 100Hz-15 KHz+/-3dB

S/N: >105dB

Distortion: <0.5%

Operation temperature -10°C~ 40°C

T.H.D: <0.5% (at 10KHz Deviation)

Power Supply: DC 12~15V

Audio output: Balanced & unbalanced

LCD displays: Accumulative working time after battery

Replacement, frequency, RF input level, AF level, battery status

Muting RF level and wireless channel information.

Specifications of the Receiver

Receiving Mode: PLL synthesized oscillation mode

Inter Frequency: First 110MHZ, second; 10.7MHz

Antenna Type: BNC type/50 Ohms

Sensitivity: 12 dB μ V (80dBS/N)

Sensitivity range: 12-32 dB μ V

Spurious Emission: \geq 75dB

Max audio output: +10 dBV

Spec of Transmitter: Antenna, Built

RF Output: Hi: 30mW: LO: 3mW

Spurious Emission: -60dB

Operation Battery: AA x 2